



Block Nuisance Calls

## User Guide



**BT3960 Nuisance Call Blocker**  
Digital Cordless Phone with Answer Machine

# Important – please read first

---

- Only use the line cord, power supply and rechargeable batteries that come with your phone.
- Make sure the power supply is connected to a socket that you know works.
- Connect your phone to the power supply and let the batteries charge for 16 hours before connecting your phone to the phone socket.
- The base should always be plugged in to the mains power supply.

## **Your Answer Machine**

Make sure the phone is set to Answer & Record and that the ring delay is set to answer before any voicemail service does. The default setting is five rings. If you want to change it, take a look at page 36.

## **Where to put your phone**

To make sure your handset gives you the best range and reception, avoid interference by placing it away from any large metal objects like fridge-freezers, microwave ovens, or electronic products such as computers and TVs.

## **Call Blocking**

For the call blocking feature to work you will need to subscribe to a Caller Display service from your network provider. You might have to pay a fee.

# Check the box contents



Handset

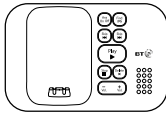

Base

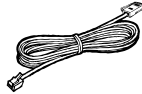

Phone line (this comes already installed)

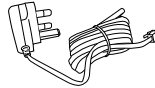

Mains power adaptor  
(item code 087314)



Two rechargeable  
batteries, AAA NiMH  
300mAh

## If you bought more than one handset you'll also get



Extra  
handset



Charger

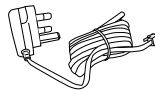

Mains power adaptor  
(item code 087314)



Two rechargeable  
batteries, AAA NiMH  
300mAh

### ! IMPORTANT

Only use the mains power adaptors, cables and rechargeable batteries supplied in this box or this product might not work. Any replacement rechargeable batteries must be of the same type. BT accepts no responsibility for damage caused to your BT3960 if you use any other type of batteries.

# Set up

## Where to put your phone

- Place the base within 3 metres of a mains power socket and 1.8 metres of a phone socket so the cables will reach.
- Make sure it's at least a metre away from other electrical appliances to avoid interference.
- Don't place the phone or base in a bathroom or other humid area.
- The product works by sending radio signals between the handset and base. The strength of the signal depends on where you position the base. Putting it as high as possible can help give you the best signal.

## IMPORTANT

- Don't connect the phone line to a phone socket until the handset is fully charged.
- The base station should be plugged into the mains power socket all the time.

## 1 Plug in

- Your phone comes with the phone line cord already fitted. Plug the other end into the wall socket.
- Plug the mains power adaptor into the base.
- Plug the other end of the power adaptor into the wall socket and switch on.

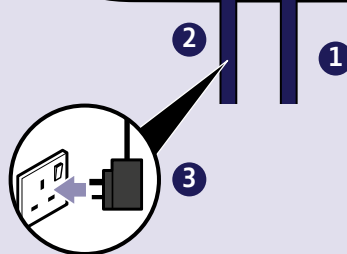
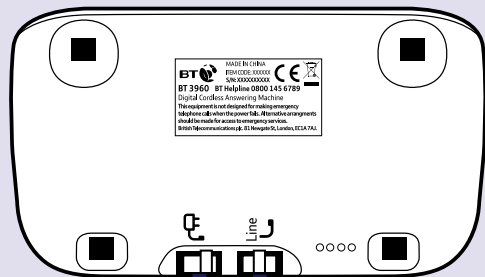

## 2 Charge

- Slide off the battery cover from the back of the handset and insert the two batteries supplied. Note the '+' and '-' markings inside the battery compartment. Then slide the battery cover back into place.
- The handset will check for a link with the base station. Once found, you'll need to set the time and date, but you can then press the  button to skip any further options until setup is complete (you can always set these up later).
- Place the handset on the base and leave to charge the batteries for **16 hours**. The handset gives a confirmation tone.

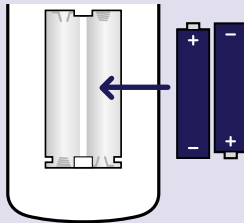

### Talk/Standby time

Under ideal conditions, the handset batteries should give up to 10 hours talk time or 200 hours standby on a single charge. (This doesn't mean you can unplug the base or leave the handset for this length of time without charge).

Please note that new Ni-MH rechargeable batteries don't reach full capacity until they've been in normal use for several days.

### Battery low warning

You will hear a warning beep every 2 minutes during a call and the  icon will flash.

You must recharge the handset batteries before you can use the handset. If the charge completely runs out the handset will switch off. Place the handset on the base or charger to charge.

If the **LOW BATTERY** message is displayed, there may be a short delay before the handset beeps and indicates the battery is charging.

### ! IMPORTANT

Charge the handset batteries for 16 hours before using the handset for the first time.

## 6 Set up

### Battery performance

- To keep the batteries in the best condition, leave the handset off the base for a few hours at a time.
- Running the batteries right down at least once a week will help them last as long as possible.
- After charging your handset for the first time, subsequent charging time for the batteries is approximately 8 hours.
- The charge capacity of rechargeable batteries will go down over time, which will reduce the talk and standby time. Eventually they'll need replacing. For details on how to get replacement batteries, call the helpline on 0800 145 6789\*.

### Set up your additional handsets (multipacks only)

If you've got a multipack, you'll need to do this for each handset.

1. Plug the mains power adaptor into the socket on the underside of the charger, secure the cable behind the retaining clip and plug the other end into the wall power socket and switch on.
2. Insert the batteries as shown on page 5.
3. Place the handset on the charger to charge for **16 hours**.

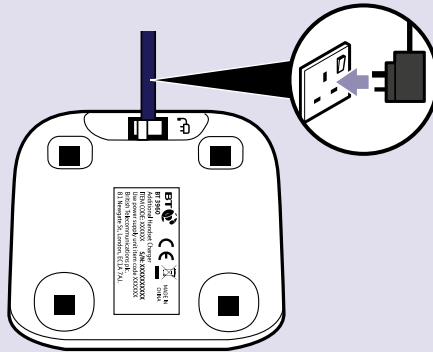

## 3 Go!

Your BT3960 is now ready for you to use

- For help setting the date and time, go to page 51.
- For instructions on making a call, go to page 18.
- For help personalising your phone's settings, go to page 45.
- For instructions on using the answer machine, go to page 36.

Or, you may find the answer in the Help section on page 56 or see our online frequently asked questions at [bt.com/producthelp](http://bt.com/producthelp)

Alternatively, call the Helpline on 0800 145 6789\*.

\* Calls made from within the UK mainland network are free. Mobile and international call costs may vary.

### Using your BT3960 on a line with broadband?

To avoid problems with your broadband or noise on your phone line, you might need to plug your telephone line cord into the wall socket via a microfilter (not supplied).

If your main phone socket has a **single** socket, you **do** need to use microfilters, like this:

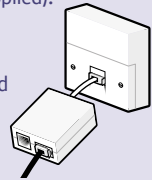

You'll need a microfilter for every phone socket where you've got equipment plugged in – up to a maximum of four per line – including alarm systems and digital TV boxes.

You can get BT ADSL micro filters from [bt.com/shop](http://bt.com/shop)

You **don't** need to use microfilters if your main phone socket has **two separate** sockets, like these:

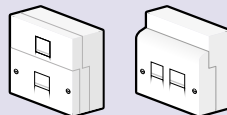

# Contents

<b>Getting to know your phone</b> .....	12	Redialling the last number.....	20
Handset buttons .....	12	VIEWing and dialling a number in the redial list.....	20
Handset display .....	13	Saving a redial number to the phonebook .....	21
Finding your way around your phone .....	14	Deleting a number from the redial list.....	21
Menu map .....	15	Deleting the entire redial list .....	21
Base buttons.....	17	Do Not Disturb.....	22
<b>Using the phone</b> .....	18	Turning Do Not Disturb off .....	22
Switching the handset on and off ....	18	Turning the handset ringer up, down or off .....	22
Making an external call.....	18	Finding your handset (paging).....	23
Preparatory dialling.....	18	<b>Call block</b> .....	24
Ending a call .....	18	Blocking calls by type .....	24
Receiving a call .....	18	Blocking a number .....	25
Mute .....	19	Viewing the Blocked list .....	25
Incoming speech/Handsfree volume..	19	Editing a number in the blocked list .	26
Handsfree.....	19		
Answering a call using handsfree ....	20		
Switching to handsfree during a call ..	20		



---

Deleting a number from the blocked list .....	26	Viewing or dialling an entry in the calls list .....	33
Deleting all of your blocked numbers .....	27	Saving a calls list entry to your phonebook .....	33
<b>Phonebook</b> .....	28	Deleting an entry in the calls list .....	34
Store a phonebook entry .....	28	Deleting all of the calls list .....	34
Character map .....	29	Adding a calls list number to the blocked list .....	35
Viewing/dialling a phonebook entry ..	29	<b>Answer machine</b> .....	36
Searching alphabetically for a phonebook entry .....	30	Using the answer machine from the handset .....	36
Editing a phonebook entry .....	30	Switching the answer machine on or off from the handset .....	36
Adding a pause to a saved number ....	30	Outgoing messages .....	36
Deleting a phonebook entry .....	31	Recording your own outgoing message .....	36
Deleting the entire phonebook .....	31	Playing the current outgoing message .....	37
<b>Caller display and the calls list</b> .....	32	Recording a memo .....	38
Caller display .....	32		
The calls list .....	32		

## 10 Contents

---

Setting the answer mode .....	38	<b>Handset settings</b> .....	45
Setting the answer delay .....	39	Setting the handset ringtone .....	45
Playing messages using the handset..	40	Setting the handset ringer volume ...	45
Message playback .....	40	Turning the handset tones on or off ..	45
Deleting all old played messages .....	41	Changing the handset name .....	46
Using the answer machine from the base .....	41	Changing the call settings .....	47
Switching the answer machine on or off at the base .....	41	<b>Base settings</b> .....	48
Playing messages using the base .....	41	Setting the base ringtone .....	48
Message playback on the base.....	42	Setting the base ringer volume .....	48
Deleting all played messages .....	42	Change the system PIN .....	49
Remote access .....	43	Reset .....	50
Setting or changing the remote access PIN .....	43	<b>Clock/Alarm</b> .....	51
Turning remote access on or off .....	43	Setting the date and time.....	51
Operating your answering machine remotely .....	44	Setting an alarm .....	51
		Switching the alarm off .....	51

**Using additional handsets** ..... 52

Registering an additional handset .... 52

De-registering a handset ..... 53

Making an internal call between  
handsets ..... 53

Transferring a call ..... 54

Holding a three-way call ..... 55

**Help** ..... 56

**General information** ..... 60

Safety..... 60

Cleaning ..... 61

How to recycle your equipment ..... 61

Guarantee..... 61

Technical details..... 62

R&TTE..... 63

Declaration of Conformance ..... 63





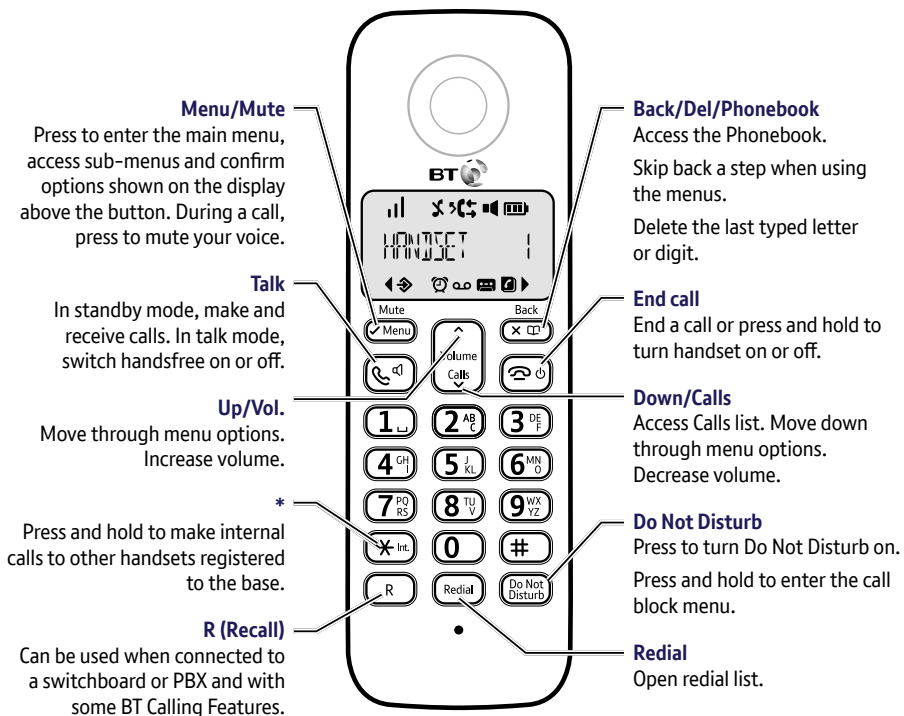



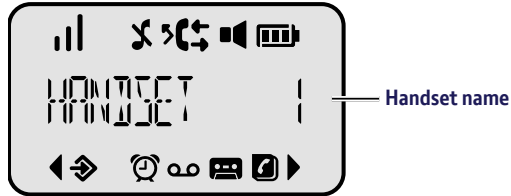



# Getting to know your phone

## Handset buttons



## Handset display











-  Shows you how much charge is left on the handset. It'll move when your phone is charging and flash when the battery is nearly empty.
-  Appears if you're on, or starting, a call.
-  Flashes to indicate new missed calls.
-  Shows when there is a new call when viewing the calls list.
-  Shows when there is an outgoing call in the redial list.
-  Shows the menu is open.
-  Shows when you're viewing the phonebook.
-  Shows when you've switched your handset ringer off.
-  Lets you know when the answering machine is switched on. Flashes when you have a new message.
-  Lets you know the signal range from your new phone's base.
-  Shows when you've set an alarm.
-  Shows when handsfree is switched on.

## Finding your way around your phone

Your new phone's menu is easy to navigate. Each menu has a list of options, which you can see on the next page.

### When the handset is switched on and at the home screen

1. Choose menu by pressing .
2. Use the  or  buttons to scroll through the available menu options.
3. When the menu you want is on the screen, press the .
4. Use  and  to scroll through the available menu options. To go back, press . To return to the home screen menu, press . If you don't press anything for 30 seconds, the handset will automatically return to the home screen.

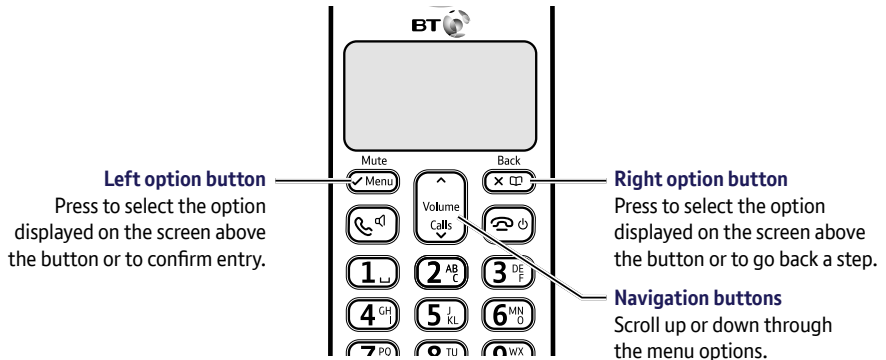

## Menu map

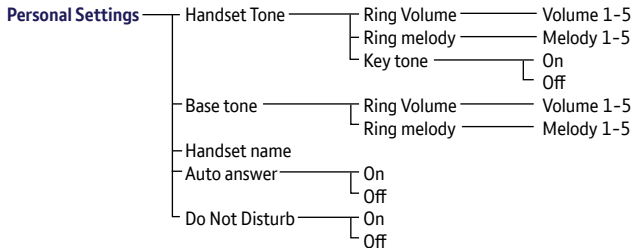
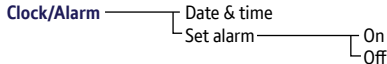
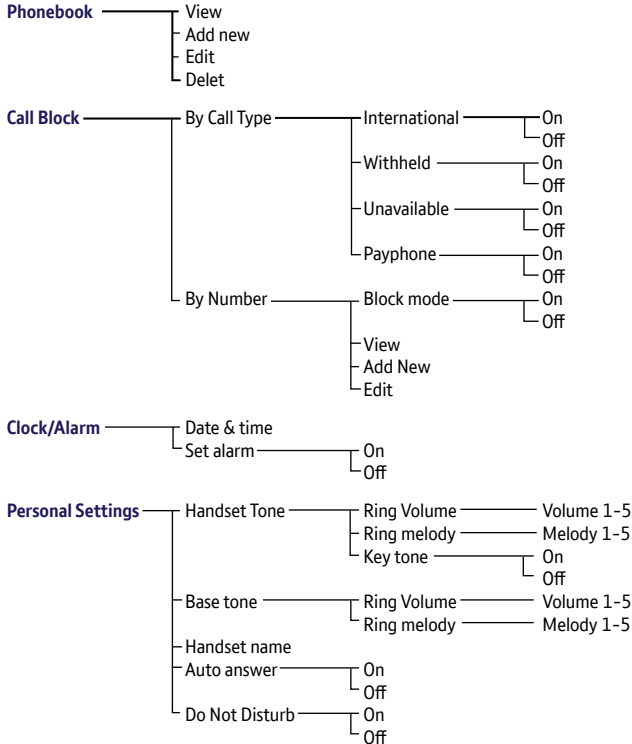

## 16 Getting to know your phone

---

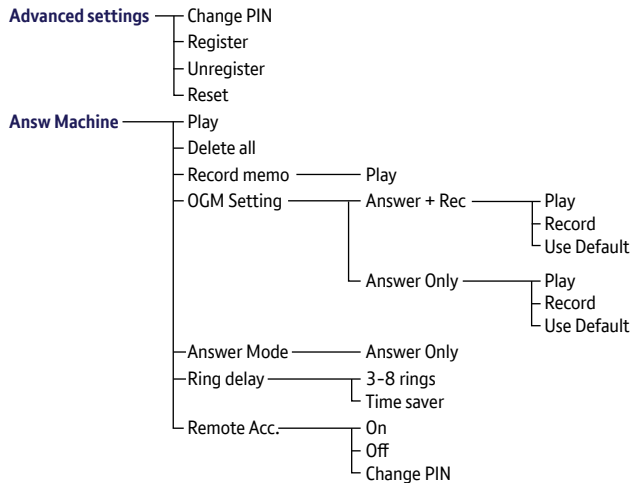



## Base buttons

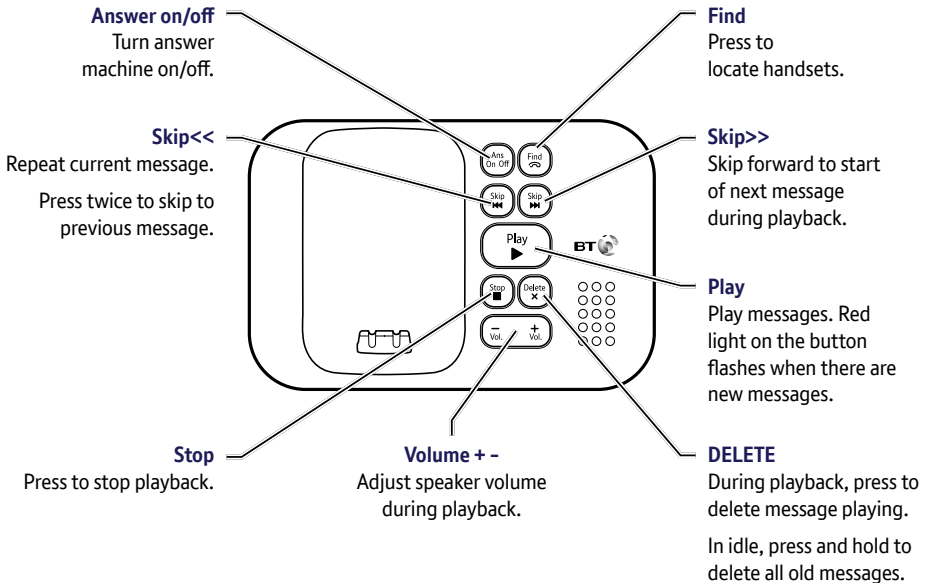

# Using the phone

## Call timer

Your handset will automatically time your outgoing and incoming calls. The call timer will display after the first 10 seconds of the call. Once the call has ended, the total call time will show on the display for 3 seconds.

## Auto answer

If auto answer is set to On you can end a call by placing the handset back in the base. If auto answer is set to Off, you'll need to press  to end the call. Auto answer Off is the default setting, see page 47.

## Switching the handset on and off

1. Press and hold  until the handset turns on or off.

## Making an external call

1. Press .
2. When you hear the dial tone, type the number. When the call begins, the light on the phone's base will flash.



## Preparatory dialling

This lets you type in the number first, to avoid mistakes before the call is connected. If you do make a mistake, select  to delete the last digit.



## Ending a call

Press .



## Receiving a call

When you get a call, your phone will ring and the  icon will flash on the display. If you've got a caller display service, the caller's number will show on the display. Press  to answer the call. When you've finished talking, press  to hang up.

## Mute



1. During the call, press  to mute your microphone. Your display screen will show **MUTE ON**, so you'll know your caller can't hear you.
2. Press  again to unmute. The display will go back to showing the call length.

## Incoming speech/Handsfree volume

To turn the volume up or down during a call, use  and . The first press will bring up the current volume. When you press them again, you'll hear the volume change.

## Handsfree

Handsfree lets you talk to your caller without holding the handset. It also means anyone in the room can listen to the call as well.

1. Type the number you want to call and then press  twice. You'll hear your call on the loudspeaker. Press  to switch between the earpiece and loudspeaker.
2. Press  to end the call.

When you're on a call, you can mute the microphone, so the person at the other end can't hear you.

### Out of range warning

The  icon on the handset display lets you know you're within range of the base. If you go out of range the icon will disappear.



If you're on a call and go out of range, you'll hear a warning beep. You'll need to move back within range of the base.

If you do lose the connection, the handset will automatically re-connect to the base when you move back in range.

### Answering a call using handsfree

When your phone rings, press  after you've answered it. Your call will be transferred to the handset loudspeaker.



### Switching to handsfree during a call

During a call, press  to put it on loudspeaker. To switch handsfree off and go back to the earpiece, press  again.





## Redial

You can redial any of the last ten numbers you've called on your BT3960.

### Redialling the last number

1. Press . Your last dialled number will show on the display screen.
2. Press  to call it.

### VIEWing and dialling a number in the redial list

1. Press . The last number will show.
2. Press  and  to get to the number you want.
3. Press  to connect your call.

### Saving a redial number to the phonebook

1. Press **Redial** and use the arrow buttons to get to the number you want to save.
2. Press **Menu**. **SAVE NUMBER** is displayed, press **Menu**.
3. Use the keypad to type in the name and press **Menu**.
4. If you need to, edit the number and press **Menu**.

### Deleting a number from the redial list

1. Press **Redial**, then use the arrow buttons to scroll through to the number you want to delete.
2. Press **Menu** and then **Calls** to get to **DELETE**. Press **Menu**.
3. You'll be asked to confirm. Press **Menu** again.

### Deleting the entire redial list

1. Press **Redial** and then **Menu**.
2. Press **Calls** until you see **DELETE ALL**. Press **Menu**.
3. You'll be asked to confirm. Press **Menu**.

### Do Not Disturb

The Do Not Disturb feature lets you choose for calls to ring silently. When set to **ON**, the base and handset(s) won't ring.





The handset backlight won't come on and the only sounds the handset will make are the 'battery low' and 'out of range' warnings. The base call screening and message alert will also be set to low.

### Turning Do Not Disturb off

When you have Do Not Disturb switched to On, it'll show on the screen when your phone is in idle mode.

1. When you're on the handset's standby screen, press  to turn the feature **ON** or **OFF**. The setting you've changed it to will show on the display and the handset will play the confirmation tone.



### Turning the handset ringer up, down or off

1. Open the main menu by pressing , then scroll through to **PERSONAL SET** using .
2. You'll see **HANDSET TONE** on the display screen, press .
3. Use  to find **RING VOLUME** and press .

4. Use the arrow buttons again to scroll through the volumes. Choose between volumes 1–5 or **OFF** and press . Mute

### **Finding your handset (paging)**

You can alert a handset user that they are wanted or locate a missing handset. Paging calls can't be answered by a handset.

1. Press  on the base. All handsets registered to the base will ring.
2. To stop the ringing, press  on the base again or press any button on the handset.

# Call block







## When blocking calls by type

The caller name is not shown either on the display or logged in the call list. Only **BLOCKED CALL** is shown with number if received.

Your BT3960 can block calls by type or BY NUMBER. To get the most out of it, you'll need to subscribe to a Caller Display service from your network provider. Charges may apply.

## Blocking calls by type













You can choose to block International, Withheld, Unavailable or Payphone numbers.

1. To block one of these call types, press  to open the menu.
2. Press  to get to **CALL BLOCK** and then press .
3. You'll see **BY CALL TYPE** on the display screen. Press .
4. Use the arrow buttons to scroll between **INTERN'L**, **WITHHELD**, **UNAVAILABLE**, **PAYPHONE**. When you've found the one you want, press .
5. Use the arrow buttons to scroll between **ON** and **OFF** and press .







## Blocking a number









You can block specific numbers by adding them to a list. For this setting to work, you'll need to switch it On. If you add a number to this list, your phone will only ring silently.

1. Open the menu and press  until you get to **CALL BLOCK**. Press .
2. Press  until you get to **BY NUMBER** and press .
3. Turn the setting On by pressing  until you get to **BLOCK MODE** and press .
4. Press  and  to get to **ON**, then press .
5. Press  until you see **ADD NEW** and press .
6. Type in the number you want to block, then press  to save it.







## Viewing the Blocked list

1. Press  to open the main menu and then use the arrow buttons to find **CALL BLOCK**. Press .
2. Press  to find **BY NUMBER** and press .
3. Use the arrow buttons again to find **VIEW**. Press .









### Editing a number in the blocked list

1. Press  then press  until you see **CALL BLOCK**. Press .
2. Press the arrow buttons to scroll through to **BY NUMBER** and press .
3. Press  to get to **EDIT**, then press .
4. Find the number you want to edit and then press . When you've finished editing it, press  to save your changes.

### Deleting a number from the blocked list

1. Press . Scroll  to **CALL BLOCK** and press .
2. Use the arrow buttons to get to **BY NUMBER** and press .
3. Press  until you see **DELETE**. Press .
4. The first number in your blocked list will show on the screen. Use the arrow buttons to scroll through to the number you want to delete. When you've found it, press . Then press it again to confirm.

### Deleting all of your blocked numbers

1. Press  then press  to get to **CALL BLOCK**.  
Press .
2. Press  until you see **BY NUMBER** on the display screen. Press .
3. Press  until you get to **DELETE ALL**. Press .
4. **CONFIRM?** will show on the handset display screen.  
Press .

# Phonebook

If you make a mistake, press

 to delete the last letter you typed. To add a space, press **1**.







You can get to your phonebook by pressing .

The same number can not be stored in the Phonebook and quickdial button.





You can save up to 50 numbers to your phonebook. Names can be up to 12 characters and numbers can be 24 digits.



Use the keypad buttons to type names, using the letters above each number. For example, if you wanted to write Tom, you would press **8** once for the 'T', **6** three times for the 'o' and **6** once to enter 'm'.

## Store a phonebook entry



1. When your handset is on the home screen, press  to open the menu.
2. You'll see **PHONEBOOK**. Press . Use  and  to find **ADD NEW**. Then press .
3. Type in the phonebook entry name using the keypad, then press .
4. Add the phone number and press .

## Store quickdial numbers in buttons **1** and **2**

1. When your handset is on the home screen, press  to open the menu.
2. You'll see **PHONEBOOK**. Press . Use  and  to find **EDIT**. Then press .

3. Scroll to **1\_HOTKEY** or **2\_HOTKEY**, press  and edit name using the keypad, then press .
4. Add the phone number and press .





### Dial a quickdial memory number

To dial the quickdial number, long press button  or . The number will be dialled out automatically.



### Character map

<b>1</b>	1 space -
<b>2</b>	A B C 2
<b>3</b>	D E F 3
<b>4</b>	G H I 4
<b>5</b>	J K L 5
<b>6</b>	M N O 6
<b>7</b>	P Q R S 7
<b>8</b>	T U V 8
<b>9</b>	W X Y Z 9
<b>0</b>	0
<b>*</b>	*
<b>#</b>	#









### VIEWing/dialling a phonebook entry

1. When the handset is on the home screen, press . The first entry will show.
2. Press  and  to scroll through the entries.
3. When the phonebook entry you want shows on the screen, press  to dial it.



### Searching alphabetically for a phonebook entry

1. When the handset is on the home screen, press .
2. Use the keypad buttons to search for the name. For example, to find a phonebook entry beginning with 'S', press  four times and then use the arrow buttons to scroll through the entries until you find the one you need.









### Editing a phonebook entry

1. Press . **PHONEBOOK** is displayed, press .
2. Scroll  to **EDIT** and press .
3. Scroll  or  to the entry you want and press .
4. Edit the name and press .
5. Edit the number and press  to save.

## Adding a pause to a saved number

If your new phone is connected to a switchboard, you might need to add a pause to a stored number. A pause will normally be after the switchboard access code (for example 9). When storing a number, press and hold  and then continue typing it. To add a dash to your phonebook entry, press  twice.

## Deleting a phonebook entry

1. Press . **PHONEBOOK** is displayed, press .
2. Scroll  to **DELETE** and press .
3. Scroll  or  to the entry you want and press . The display shows **CONFIRM?**
4. Press  to confirm.

## Deleting the entire phonebook

1. Press . **PHONEBOOK** is displayed, press .
2. Scroll  to **DELETE ALL** and press .
3. The display shows **CONFIRM?** Press  to confirm.

# Caller display and the calls list

You'll need to subscribe to your network provider's Caller Display service for this feature to work. You might have to pay a fee. For more information on BT Calling Features, call BT free on 0800 800 150.

For the caller's name to be displayed, make sure you've stored the full telephone number in your contacts list, including the dialling code.

There are some incoming calls where a number is not displayed and a network message is recorded instead:

**UNAVAILABLE** = number is unavailable

**INTERN'L** = international number

**OPERATOR** = call from the operator

**PAYPHONE** = call from a payphone

**RINGBACK** = a ringback call

## Caller display

You'll need to subscribe to a caller display service to get the most out of this feature. When you do, you'll be able to see your caller's number on your handset display, as long as it's not withheld.

If the number is unavailable or withheld (which can happen if the call is coming from overseas), the number will show as **UNAVAILABLE**. If your call is coming from a payphone, **PAYPHONE** will be displayed. International calls will show as **INTERN'L**. On the display screen and operator calls will appear as **OPERATOR**. If you've requested a Ringback, that'll also show on the handset display.



If a number is stored in your handset, the caller's name will be displayed and the incoming call icon will show.

## The calls list





The calls list is where you can find all missed and received calls. The most recent call will show at the top of the list, followed by the rest in chronological order. Your calls list will store up to 20 calls. When it's full, the newest call will replace the oldest.







If you miss a call,  will show on the handset display screen.

Each number on the calls list will have an icon alongside it,  for answered calls and  for unanswered (missed) calls.

### VIEWing or dialling an entry in the calls list





1. Press  to get to the calls list. You'll see the most recent entry. If you haven't got any numbers stored to the calls list, **LIST EMPTY** will show.
2. Use  and  to scroll through the list.
3. If you want to call a number from the list, when it shows on the screen, press .

### Saving a calls list entry to your phonebook





1. Press  to get to your calls list.
2. Use the arrow buttons to scroll through to the number you want to save.
3. When you get to it, press .
4. Press  until **SAVE NUMBER** shows on the display screen. Press .
5. Type in the phonebook entry name, using the handset keypad. Press .

6. The number you're saving will be displayed. Edit it if you need to, then press  to save the number. **SAVED** will show on the display screen.







### Deleting an entry in the calls list

1. Press  to get to your calls list.
2. Use the arrow buttons to get to the list entry you want to delete and press .
3. Press  until you get to **DELETE** and press . You'll be asked to confirm, **DELETED** will then show on your screen.
4. If you want to go back to the home screen, press .

### Deleting all of the calls list

1. Press  to get to your calls list. The most recent call will show first. Press .
2. Use the arrow buttons to scroll through the menu until you get to **DELETE ALL** and press . You'll be asked to confirm. Press  to delete.

### Adding a calls list number to the blocked list

1. Press  to open the calls list.
2. Scroll  and  to the entry you want and press .
3. Scroll  to **CALL BLOCK** and press . **SAVED** is displayed.

# Answer machine

When the answer machine is on the  button will light up.

## Answer & Record

The pre-recorded Answer & Record outgoing message that allows your caller to leave a message is, "Hello, your call cannot be taken at the moment, so please leave your message after the tone".











## Answer only

The pre-record answer only outgoing message, where callers hear an announcement but can't leave a message, is "Hello, your call cannot be taken at the moment and you cannot leave a message, so please call later".

Your BT3960 can record up to 12 minutes of messages. It can be used via the base, handset and remotely from any Touchtone™ telephone.

## Using the answer machine from the handset

### Switching the answer machine on or off from the handset

1. Press   Scroll  and  to **ANSW MACHINE** and press .
2. Scroll  to **ANSWER MODE** and press .
3. Scroll  or  to display either **ANSWER ONLY**, **ANSWER + REC** or **OFF** and press .

### Outgoing messages







Your outgoing message is what your callers hear when their call goes to the answer machine.

With the pre-recorded messages, you'll get two options. **ANSWER + REC** lets callers leave a message; **ANSWER ONLY** just answers your calls.





### Recording your own outgoing message

You can record either an **ANSWER + REC** message or an **ANSWER ONLY** message. If you chose **ANSWER +**

**REC**, your caller will be able to leave a message.  
If you choose **ANSWER ONLY**, they won't.

1. To record your own outgoing message, press .
2. Press  until you get to **ANSW MACHINE**. Press .
3. Then use the arrow buttons to find **OGM SETTING** and press .
4. Then choose **ANSWER + REC** or **ANSWER ONLY** and press .
5. Scroll through to **RECORD**.
6. Press  to start recording your message. When you're done, press  again and your message will be played back to you.

### Playing the current outgoing message





1. Press  to get to the menu.
2. Press  until you get to **ANSW MACHINE**. Press .
3. Then press the arrow buttons until you find **OGM SETTING**. Press .
4. Then choose between **ANSWER + REC** or **ANSWER ONLY** and press the  button.

The default outgoing message is ANSWER + REC.

5. When you see **PLAY** on the display screen, press . Your current message will be played back to you.



### Recording a memo

When you record a memo, it's saved on your answer machine and can be played back by other users like a normal answer machine message.



1. Press  to bring up the handset menu.
2. Press  until you get to **ANSW MACHINE**. Press .
3. Press  until you see **RECORD MEMO**. Press .
4. Follow the onscreen prompt and record your memo. Select **SAVE** when you're finished.
5. Your memo will then be played back to you.

### Setting the answer mode

As mentioned on page 36, there are two answering machine modes: **ANSWER + REC** and **ANSWER ONLY**. Answer + Rec also lets callers leave a message. Answer Only doesn't. Here's how to set it.

1. Press  to get to the handset's main menu.
2. Press  until you get to **ANSW MACHINE**.









Press .

3. Press  until you see **ANSWER MODE** and press .
4. Use the arrow buttons to choose the answer mode you want and press .

### Setting the answer delay

Answer delay is the number of times the phone will ring before the answer machine picks the call up for you. You can choose from two to nine rings and Time saver.

If you've got Time saver switched on, when you call in to check your answer machine messages remotely, it'll only answer the call after five rings if you don't have new messages. That way, you won't get charged for the call if you haven't got any messages to check.

1. Press , scroll  to **ANSW MACHINE**, then press .
2. Press  until you get to **RING DELAY**. Press .
3. Press  and  to get to the number of rings you want and press .





### For compatibility with BT Answer 1571 (or another voicemail service)

If you use BT Answer 1571, or another voicemail service, make sure the answer delay is set so your answer machine will pick up the call before the voicemail service does. So your answer delay should be less than the answer delay on your voicemail service.

Please note that any blocked calls will still be able to leave a message on your 1571 voicemail service.



### Playing messages using the handset

When you get a new message, a message will show on the handset display screen.

1. To play it, press  on your handset.
2. If there are no new messages, you can play your old messages. Press  to get to **ANSW MACHINE**, then press .
3. **PLAY** will show on the screen. Press  and your messages will be played in the order they were left, with the most recent first. If you've got caller display, the number of the caller and the date and time they left the message will be shown on the screen.

### Message playback







When you're playing messages, press  to display the following options: **REPEAT**, **NEXT**, **PREVIOUS** and **DELETE**.

Use the  and  buttons to scroll through the options and press  to select one.

Press  to stop playback and return to standby.



## Deleting all old played messages

1. Press , then scroll  or  to **ANSW MACHINE** and press .
2. Press  until you get to **DELETE ALL**. Press .
3. You'll be asked to confirm. Press .

## Using the answer machine from the base

### Switching the answer machine on or off at the base

To turn the answer machine on and off using the base, just press .

### Playing messages using the base

Press  to play your messages. New messages will be played first, followed by those you've already listened to.

### Message playback on the base

During playback, you can press:



to stop playback.



to delete the message being played.



to skip to the next message.



to skip back to the start of the message.



twice to skip to the previous message.



to turn the playback volume up or down.









### Deleting all played messages

1. When the base isn't in use, press and hold  on the base for 2 seconds to delete all old messages.









## Remote access

With Remote access, you can listen to your answer machine messages from another phone. You'll need to set a PIN. The default PIN is 0000, the feature will need to be switched On for it to work.

### Setting or changing the remote access PIN

1. Press , scroll  to **ANSW MACHINE** and press .
2. Press  until you see **REMOTE ACC.** and press .
3. Press  until you get to **CHANGE PIN.** Press .
4. Type your current 4 digit PIN (0000 if you haven't already set one). Press .
5. Type in your new 4 digit PIN and press  and then repeat this step. Your new PIN will be saved.

### Turning remote access on or off

1. Press , then scroll  to **ANSW MACHINE** and press .
2. Press  until you get to **REMOTE ACC.** and press .
3. Press  and  to choose between **ON** and **OFF**, then press  to confirm.









## Operating your answering machine remotely

1. Dial your number from another phone.
2. When you hear your outgoing message, press **#** and then enter your 4 digit remote access PIN (default PIN is 0000). You will hear a confirmation beep.
3. You can then follow the voice prompts to:
  - 1** replay previous message
  - 2** play all messages
  - 3** play next message
  - 6** delete current message
  - 7** switch answer machine on
  - 8** stop playback
  - 9** switch answer machine off









# Handset settings

## Setting the handset ringtone

You can choose from five ringtones.

1. Press , scroll  to **PERSONAL SET**, press .
2. **HANDSET TONE** will appear on the screen, press .
3. Press  to **RING MELODY**, press .
4. Press  or  to hear the ringtones, press  to save.

## Setting the handset ring volume



1. Press , scroll  to **PERSONAL SET**, press .
2. **HANDSET TONE** will appear on the screen, press .
3. **RING VOLUME** will show, press .
4. Press  or  to adjust the volume, press  to save.



## Turning the HANDSET TONES on or off

Each time you press a button on your keypad, a tone will sound. You can set this to on or off. The default setting is On.

1. Press , scroll  to **PERSONAL SET**, press .
2. **HANDSET TONE** will appear on the screen, press .







There are 5 volume levels or Off.

When the phone rings you can adjust the volume using the  and  buttons.

3. Press  until you get to **KEY TONE**. Press .
4. Then use the arrow buttons to scroll between **ON** and **OFF** and press .









### Changing the handset name

You can personalise your handset name, using up to ten characters. You can change it back at any time by following the steps below and then deleting all of the characters and pressing .

1. Press , scroll  to **PERSONAL SET**, press .
2. Press  until you get to **HANDSET NAME**. Press .
3. Type in the name you want to give your handset using the keypad and press  to save.

## Changing the call settings

You can set your BT3960 to Auto Answer, which lets you answer a call by taking the handset off of the base when it's ringing, without having to press any buttons.











1. Press , scroll  to **PERSONAL SET**, press .
2. Scroll  to **AUTO ANSWER**, press .
3. Press  or  to select **ON** or **OFF** and press  to save.

# Base settings









There are 5 ringtones to choose from.

There are 5 volume levels and Off.

## Setting the base ringtone

1. Press , scroll  to **PERSONAL SET**, press .
2. Press  until you get to **BASE TONE** and press .
3. Press  until you get to **RING MELODY**. Press .
4. The base will play your current ringtone. Press  and  to choose then press .









## Setting the base ringer volume

1. Press , scroll  to **PERSONAL SET**, press .
2. Press  until you get to **BASE TONE** and press .
3. **RING VOLUME** is displayed, press .
4. The base will ring at its current volume. Use the  and  buttons to choose the volume you want.
5. When you've chosen the right volume, press  to save your changes.



## Change the system PIN







To change some of the settings on your phone, you'll need to give your access PIN. This is a four-digit number and the default is set to 0000.

1. Press   to **ADVANCED SET** and press .
2. Press  until you see **CHANGE PIN** on the display screen and press .
3. If you haven't set one before, you'll be prompted to set a four-digit PIN. When you've done it, press . Or if you're changing a PIN you've already set, you'll be asked to type in the current PIN. Then follow the instructions on the screen to set a new one and press .
4. Enter your new PIN again and press . **SAVED** will show on the screen.

## Reset







If you choose to do this, your BT3960 will go back to the settings it had when it arrived.

Your phonebook will still be saved on your phone if you reset.











1. Press , scroll  to **ADVANCED SET** and press .
2. Press  until you get to **RESET** and press .
3. **RESET?** will show on the screen. Press  to confirm. Your phone will restart automatically.

# Clock/Alarm

## Setting the date and time



1. Press , scroll  to **CLOCK/ALARM** and press .
2. **DATE & TIME** is displayed, press .
3. Use the keypad to type in the date (e.g. DD-MM-YY) and press .
4. Enter the time (e.g. 06-30 for 6.30) and press  to save.

## Setting an alarm

1. Press , scroll  to **CLOCK/ALARM** and press .
2. Scroll  to **SET ALARM** and press .
3. Press  and  to select **ON** or **OFF** and press .
4. If you selected On, enter the time you want to set the alarm for and press . When you've set your alarm, the  icon will show on the display screen.

## Switching the alarm off

When the alarm goes off, the screen will light up and the alarm tone will sound. To switch it off, press any button.

Press  or  to toggle between 'A' for AM or 'P' for PM.

# Using additional handsets

You can register up to four GAP compliant handsets to your BT3960 base to extend your phone system, without needing to install telephone extension sockets for each new phone.

If registration isn't successful the first time, please try again in case the base registration period ran out of time.

If there are already four handsets registered to the base, the registration will fail. You must de-register another handset before you can register the new one (see next page).

## Registering an additional handset

If you bought your BT3960 as a multipack, all the handsets that came with it will already be registered to the base.





If you buy new handsets separately, you'll need to register them before you can use them. You can register up to four handsets.





Once the registration process has started, you need to complete it within two minutes. If you run out of time you can start again.

At the base:

1. Press and hold  for 5 seconds until you hear a beep. You now have 90 seconds to register a handset.

At the handset:

2. If the handset isn't registered to a base, press   and then enter the 4 digit PIN (default is 0000) and press  .









Or, if the handset is already registered to a base, press   and scroll  to **ADVANCED SET** and press  .

3. Press  until **REGISTER** is displayed. Press  .

4. You'll be asked to confirm your PIN. Type in your 4 digit PIN (default is 0000) and then press . You will hear a beep if registration is successful and the handset is automatically assigned an available handset number.

### De-registering a handset

You'll need to use one handset to de-register another. You can't de-register the handset you're using.

1. Press , scroll  to **ADVANCED SET** and press .
2. Press  until you come to **UNREGISTER**. Press .
3. Type your 4 digit PIN (default is 0000), then press .
4. Scroll  or  to select the handset number to de-register and press . You will hear a confirmation beep.

### Making an internal call between handsets





If you've got more than one handset registered to your base, you can make internal calls between them.

1. If there's only 2 handsets registered to the base, press and hold  and the other handset will ring automatically.

### Registering another make of handset to your BT3960 base

If you want to register another make of handset (i.e. not a BT3960 handset) to your BT3960 base you will need to follow the registration instructions that came with the handset first and then continue with the base part of the registration procedure (as shown in point 1 on page 52).



Please note that registering other types of handset will only provide limited compatibility, i.e. you may only be able to make and receive calls and the CALL BLOCKING feature may not work.

2. If there are more than 2 handsets registered, press and hold   and then scroll  to the handset you want to call and press .





### **Transferring a call**

You can transfer an external call from one handset to another registered to the base.

#### **During an external call:**

1. If there's only 2 handsets registered to the base, press and hold   and the other handset will ring automatically.







Or,

2. If there are more than 2 handsets registered, press and hold   and then scroll  to the handset you want to call and press .
3. When the other handset answers, press  to complete the transfer.

### Holding a three-way call

You can hold a three way call between 2 internal callers and 1 external caller.

#### During an external call:

1. If there's only 2 handsets registered to the base, press and hold  and the other handset will ring automatically.  
Or,
2. If there are more than 2 handsets registered, press and hold  and then scroll  to the handset you want to join the call and press .
3. When the other handset answers, press and hold  to connect all 3 callers.
4. Press  to end the call.

# Help

---

## **My phone isn't working**

- Have you activated the batteries correctly? See page 5.
- Check that the mains power is correctly connected.

## **No dial tone, or a line cord error message is displayed on the screen**

- Is the phone cord plugged into the base and phone wall socket?
- Check that the mains power is correctly connected.
- Only use the phone cord supplied with the phone.

## **Can't make or receive calls**

- Check that the mains power is correctly connected.
- The batteries may need recharging.
- Has there been a power cut? If so, place the handset back on the base for ten seconds and try again. If it still doesn't work, disconnect the batteries and mains power for ten minutes, then reconnect and try again.

## **You have a dial tone but the phone won't dial out**

- If you're connected to a switchboard, check whether you need to dial an access code.

## **Handset doesn't ring**

- The person calling maybe in your block list. See page 25.
- The ringer volume may be switched off. See page 45.
- Check that the mains power is correctly connected.



- Do Not Disturb may be switched on. See page 22.
- Make sure the handset is registered to the base. See page 52.

### **No display**

- The batteries may be flat, dead or incorrectly inserted.
- Recharge or replace the batteries.

### **Range icon flashes**

- Make sure the handset is registered to the base. See page 52.
- Check that the mains power is correctly connected to the base.
- Check that the handset is within range of the base.
- If the batteries are low, place the handset on the base/charger to recharge.

### **You hear the busy tone when you press**

- Make sure the handset is in range of the base.
- Another handset registered to your BT3960 base may be on the line.

### **No caller display number or name is displayed**

- Have you subscribed to a caller display service from your network provider? See page 32.
- The caller may have withheld their number.
- The network might not have the caller's number information.
- There isn't an exact name or number match in your phonebook. Check that you've stored the full STD dialling code.

### **Can't register a handset to a base**

- You can register up to four handsets to your BT3960 base and you can register your BT3960 handset to up to four bases. Check that you haven't gone over the limits.
- Check that you've entered the correct system PIN number (default PIN 0000).
- Check that you're at least one metre away from other electrical equipment to avoid interference when registering.

### **Base unit doesn't ring but the lights are on**

- Have you connected the phone line correctly?
- Do Not Disturb may be switched on. See page 22.
- Is the base ringer set to Off?
- You may have a faulty line or socket. Try using another socket or line. Call your network provider or, if you're a BT customer, please call 0800 800 151 if you still have problems.
- The person calling maybe in your block list. See page 25.

### **Buzzing noise on my phone or on other electrical equipment nearby**

- Sometimes other electrical equipment can interfere with your BT3960 if it's placed too close. We recommend that you place your BT3960 at least one metre away from electrical appliances or metal obstructions to avoid any risk of interference.

### **Customer helpline**

If you're still having problems, call us on 0800 145 6789\* or go to **bt.com/producthelp**

### **General sales enquiries**

- BT residential lines, call 150. BT Business lines, call 152.
- Non-BT line customers, call 0800 800 150 (residential) or 0800 800 152 (business).
- To buy extra handsets, call us on 0800 145 6789\*.

### **Billing enquiries**

Please see the phone number shown on your BT bill.

# General information

## Important

**This equipment is not designed for making emergency phone calls when the power fails. So you won't be able to call 999 from this phone if there's a power cut or it's not plugged in, so make sure you've got another way to call for help in an emergency.**

This product is intended for connection to analogue public switched phone networks and private switchboards in the United Kingdom.

## Replacing the handset batteries

After a time, you might find that the handset batteries run out of charge more quickly. This is a standard sign of wear and the batteries will need replacing.

1. Open the battery compartment cover.
2. Lift the battery out and remove the batteries.  
Replace with two new AAA Ni-MH 300mAh rechargeable batteries.
3. Replace the battery compartment cover.

## Safety

- Only use the power supply suitable for the BT3960. Using an unauthorised power supply will invalidate your guarantee and may damage the phone.  
The item code for the base mains power supply is 087314. If you've bought a multiple pack, the item code for the charger mains power supply is 087314.
- Use only the approved rechargeable batteries supplied. Spare rechargeable batteries are available from the BT3960 Helpline on 0800 145 6789\*.

There is a risk of explosion if incorrect batteries are fitted.

BT accepts no responsibility for damage caused to your BT3960 by using any other types of batteries.

- Don't immerse batteries in water, throw them into a fire or dispose of them with ordinary domestic refuse.
- Don't open the handset (except to replace the handset batteries) or the base. This could expose you to high voltages or other risks. Contact the Helpline on 0800 145 6789\* for all repairs.
- Radio signal transmitted between the handset and base may cause interference to hearing aids.
- It is recommended that advice from a qualified expert be sought before using this product in the vicinity of emergency/intensive care medical equipment.
- It is recommended that if you have a pacemaker fitted you check with a medical expert before using this product.
- Your product may interfere with other electrical equipment, e.g. TV and radio sets, clock/alarms and computers if placed too close.

It is recommended that you place your product at least one metre away from such appliances to minimise any risk of interference.

- Never dispose of batteries in a fire. There is a serious risk of explosion and/or the release of highly toxic chemicals.

## Cleaning

Clean the handset and base (or charger) with a damp (not wet) cloth, or an anti-static wipe. Never use household polish as this will damage the product. Never use a dry cloth as this may cause a static shock.

## Environmental

- Do not expose to direct sunlight.
- The handset may become warm when the batteries are being charged or during prolonged periods of use. This is normal. However, we recommend that to avoid damage you do not place the product on any surface susceptible to heat damage.
- Do not stand your product on carpets or other surfaces which generate fibres, or place it in locations preventing the free flow of air over its surfaces.
- Do not submerge any part of your product in water and do not use it in damp or humid conditions, such as bathrooms.
- Do not expose your product to fire, explosive or other hazardous conditions.
- There is a slight chance your phone could be damaged by an electrical storm. We recommend that you unplug the power and phone line cord during an electrical storm.

## How to recycle your equipment

The symbol shown here and on the product means that the product is classed as electrical or electronic equipment, so DO NOT put it in your normal rubbish bin.



It's all part of the Waste Electrical and Electronic Equipment (WEEE) Directive to recycle products in the best way – to be kinder to the planet, get rid of dangerous things more safely and bury less rubbish in the ground.

You should contact your retailer or supplier for advice on how to dispose of this product in an environmentally friendly way.

## Guarantee

Your BT3960 is guaranteed for 12 months from the date of purchase.

Subject to the terms listed below, the guarantee will provide for the repair of, or at BT's or its agent's discretion, the option to replace the BT3960 or any component thereof, (other than batteries), which is identified as faulty or below standard, or as a result of inferior workmanship or materials. Products over 28 days old from the date of purchase may be replaced with a refurbished or repaired product.

### Guarantee conditions

- The guarantee shall only apply to defects that occur within the 12 month guarantee period.
- Proof of purchase is provided.
- The equipment is returned to BT or its agent as instructed.
- This guarantee doesn't cover any faults or defects caused by accidents, misuse, fair wear and tear, neglect, tampering with the equipment, or any attempt at adjustment or repair other than through approved agents.
- This guarantee does not affect your statutory rights.

### **Within the 12 month guarantee period**

Prior to returning your product, please read the Help section beginning on page 56 or contact the BT3960 Helpline on 0800 145 6789. Additional answers to frequently asked questions are available from [bt.com/producthelp](http://bt.com/producthelp)

In the unlikely event of a defect occurring, the helpdesk will issue a Fault Reference Authorisation (FRA) number and instructions for replacement or repair. Please note you will need the FRA number before returning the product. This does not affect your statutory rights.

### **Outside of the 12 month guarantee period**

If your product needs repair after the guarantee period has ended, the repair must meet the approval requirements for connection to the phone network.

We recommend that you contact BT's recommended repair agent Discount Communications on 0800 980 8999 or a local qualified repairer.

### **Returning your phone**

If the Helpline is unable to remedy your problem they will issue a Fault Reference Authorisation number and ask you to return the product to your original place of purchase. Where possible, pack the product in its original packaging. Please remember to include all parts, including the line cords, power supply units and the original batteries.

## Technical details

### **How many phones can I have?**

All items of telephone equipment have a Ringer Equivalence Number (REN), which is used to calculate the number of items which may be connected to any one telephone line. Your BT3960 has a REN of 1. A total REN of 4 is allowed. If the total REN of 4 is exceeded, the telephones may not ring. With different telephone types there is no guarantee of ringing, even when the REN is less than 4.

Any additional handsets and chargers that you register have a REN of 0.

## Connecting to a switchboard

### **Switchboard compatibility**

This telephone may be connected to most types of switchboard, however in the event of any difficulties, consult your switchboard Service Provider.

### **Recall (R)**

Recall is used when connected to certain switchboards/PBXs and some BT Calling Features, or those services available via your network provider. The BT3960 supports time break recall but not earth loop recall.

## R&TTE

This product is intended for use within the UK for connection to the public telephone network and compatible switchboards.

This equipment complies with the essential requirements for the Radio Equipment and Telecommunications Terminal Equipment (R&TTE) Directive (1999/5/EC).

## Declaration of Conformance

Hereby, BT declares that this BT3960 is in compliance with the essential requirements and other relevant provisions of Directive 1999/5/EC.

If you would like a copy of the Declaration of Conformance, please visit [bt.com/producthelp](https://www.bt.com/producthelp)

## For your records

Date of purchase:

Place of purchase:

For guarantee purposes, proof of purchase is required, so please keep your receipt.

Enter your base system PIN here:

[ / / / ]

Enter your remote access PIN here:

[ / / / ]



## Offices worldwide

The services described in this publication are subject to availability and may be modified from time to time. Services and equipment are provided subject to British Telecommunications plc's respective standard conditions of contract. Nothing in this publication forms any part of any contract.

© British Telecommunications plc 2016.  
Registered Office: 81 Newgate Street, London EC1A 7AJ.  
Registered in England No. 1800000.

Printed in China.  
Written and designed by Muse Publishing and The Art and Design Partnership

Available in other formats including braille, large print or audio CD.  
If you would like a copy, please call 0800 145 6789\*.

\* Calls made from within the UK mainland network are free.  
Mobile and international call costs may vary

BT3960 (08/16) Issue 1

